

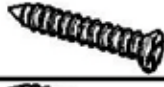







Part List

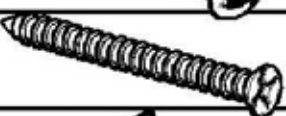



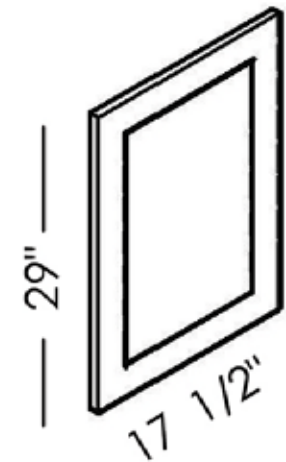
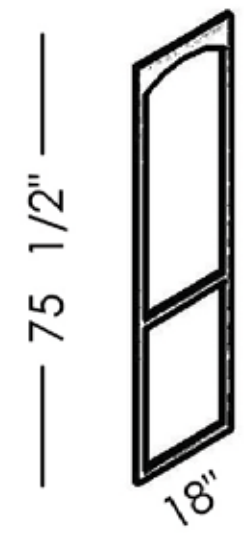
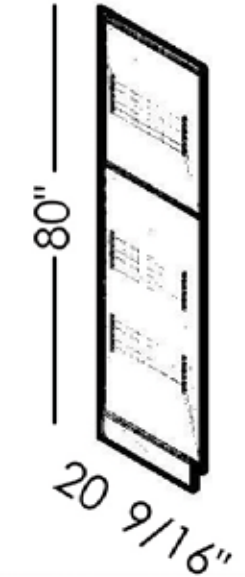
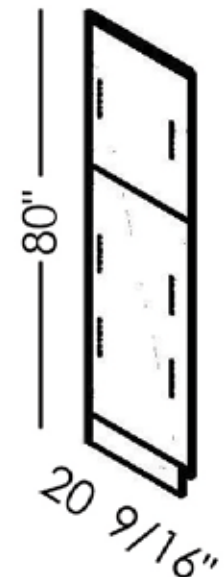
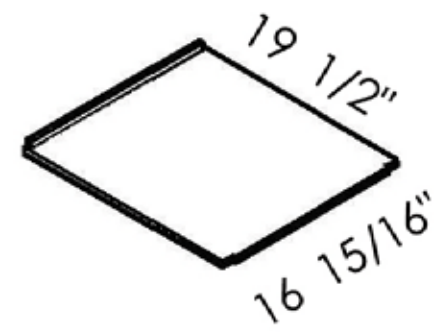
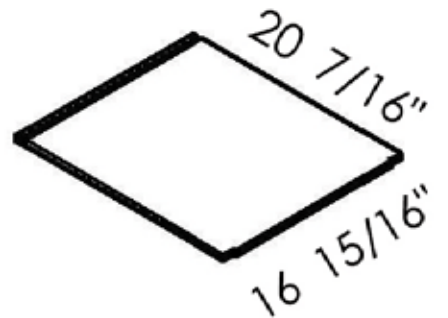
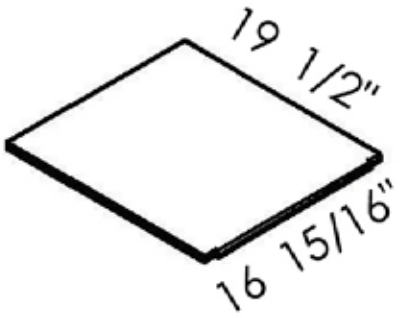
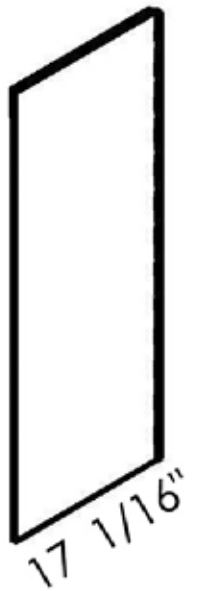

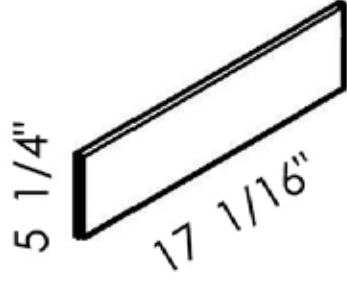
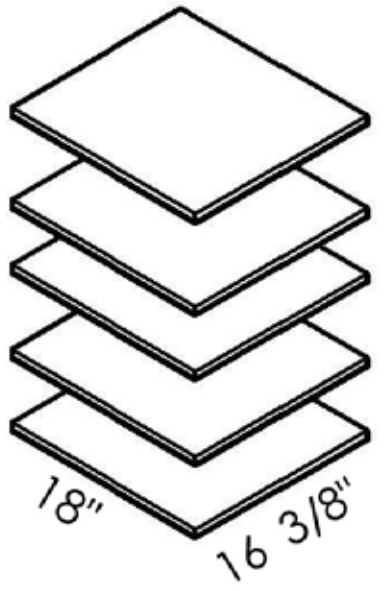
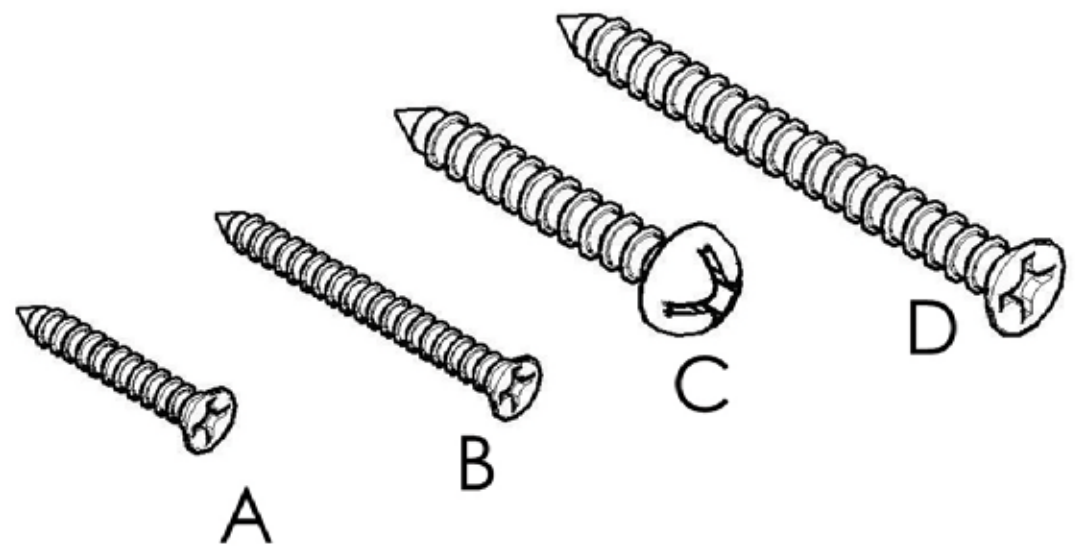

VOL188021

Unit: inch

No	Picture	Specification	Qty
A		Screw $\text{Ø}3 \times 1/2$ "	32
B		Screw $\text{Ø}3 \times 5/8$ "	4
C		Screw $\text{Ø}4 \times 5/8$ "	2
D		Screw $\text{Ø}4 \times 1 \frac{3}{16}$ "	2
E		Metal Clip	4
F		Hinges	2
G		Bumper	2
H		Shelf Clip	20

<p>1</p>  <p>Door</p>	<p>2</p>  <p>Face Frame</p>	<p>3</p>  <p>Left Side Panel</p>
<p>4</p>  <p>Right Side Panel</p>	<p>5</p>  <p>Top Panel</p>	<p>6</p>  <p>Middle Bottom Panel</p>
<p>7</p>  <p>Bottom Panel</p>	<p>8</p>  <p>Top Back Panel</p>	<p>9</p>  <p>Bottom Back Panel</p>
	<p>10</p>  <p>Front Toe kick</p>	<p>11</p>  <p>Shelf</p>
		

Assembly instructions

No	Picture	Specification	Qty	No	Picture	Specification	Qty
A		Screw $\varnothing 3 \times 1/2$ "	32	E		Metal Clip	4
B		Screw $\varnothing 3 \times 5/8$ "	4	F		Hinges	2
C		Screw $\varnothing 4 \times 5/8$ "	2	G		Bumper	2
D		Screw $\varnothing 4 \times 1 \frac{3}{16}$ "	2	H		Shelf Clip	20

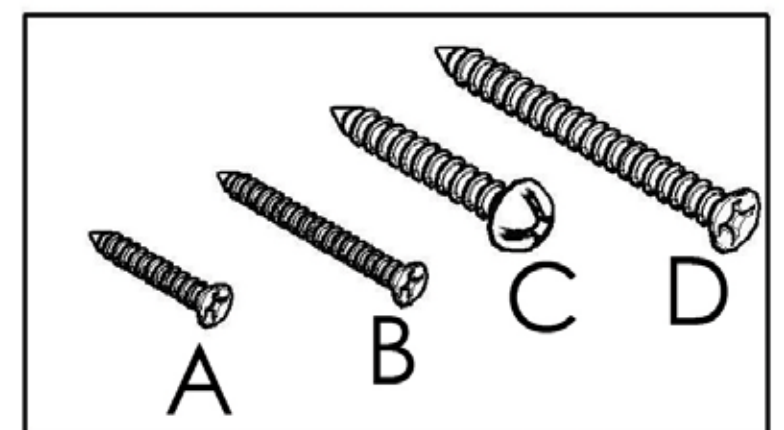
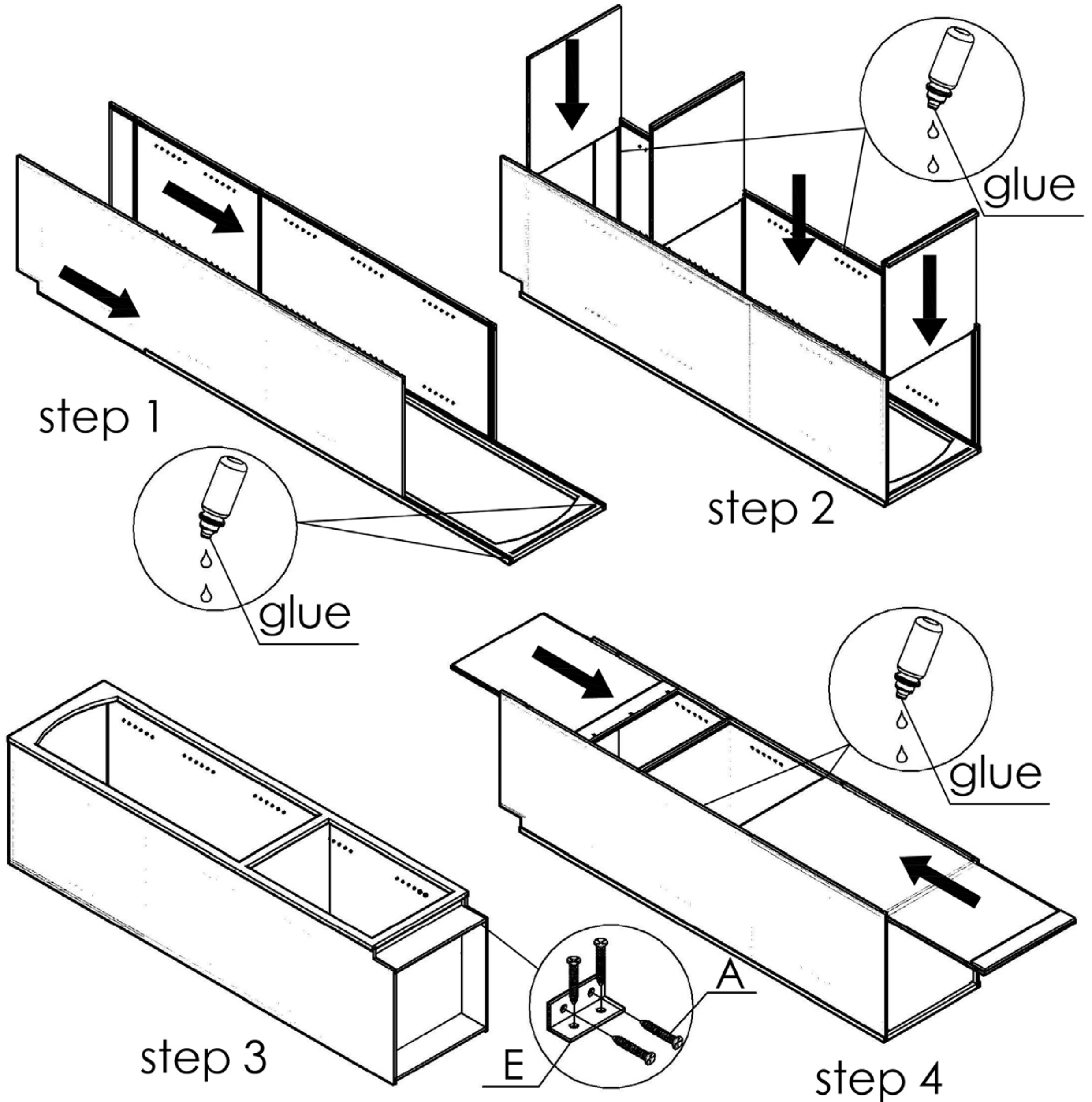

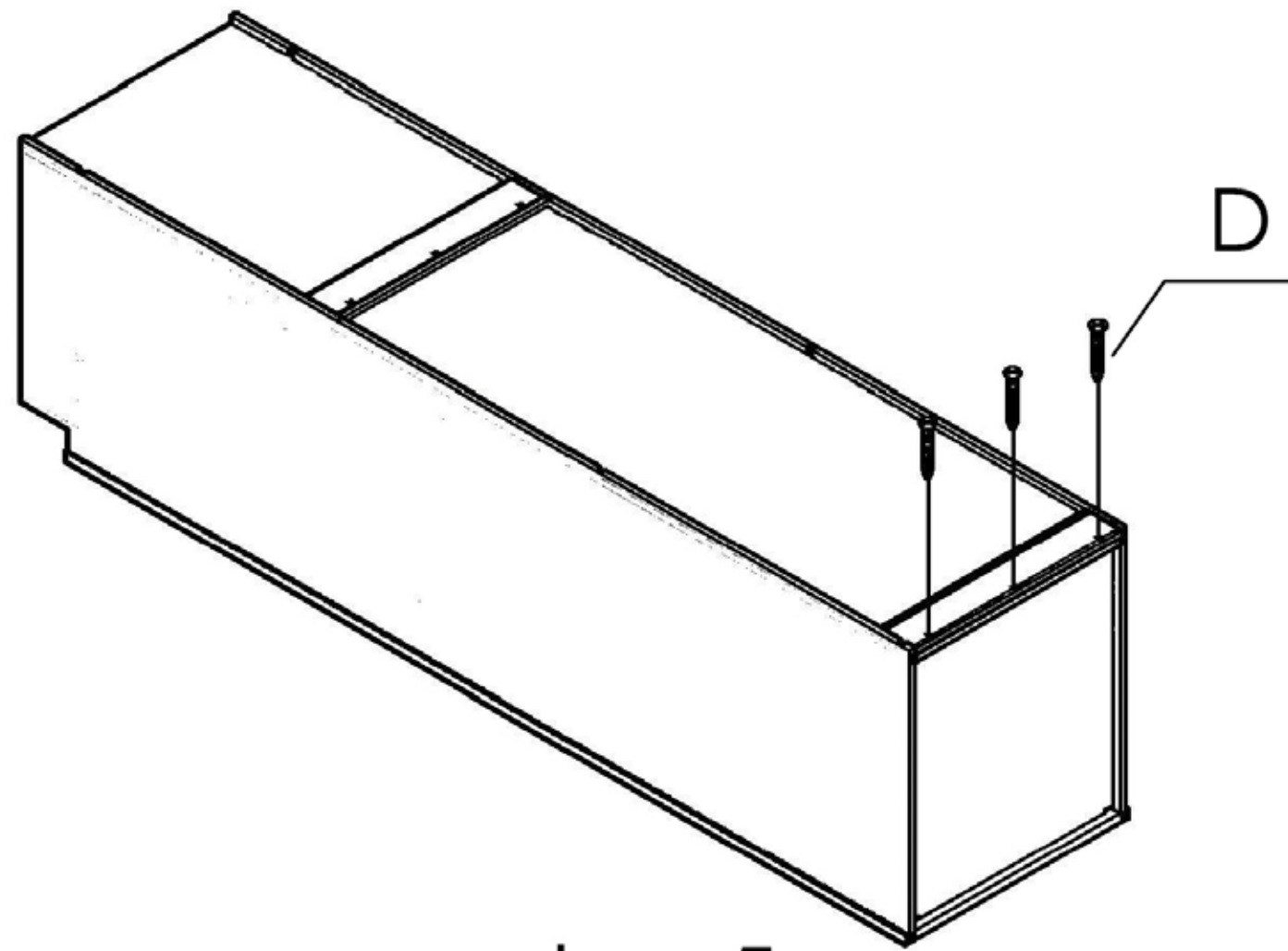

step 5

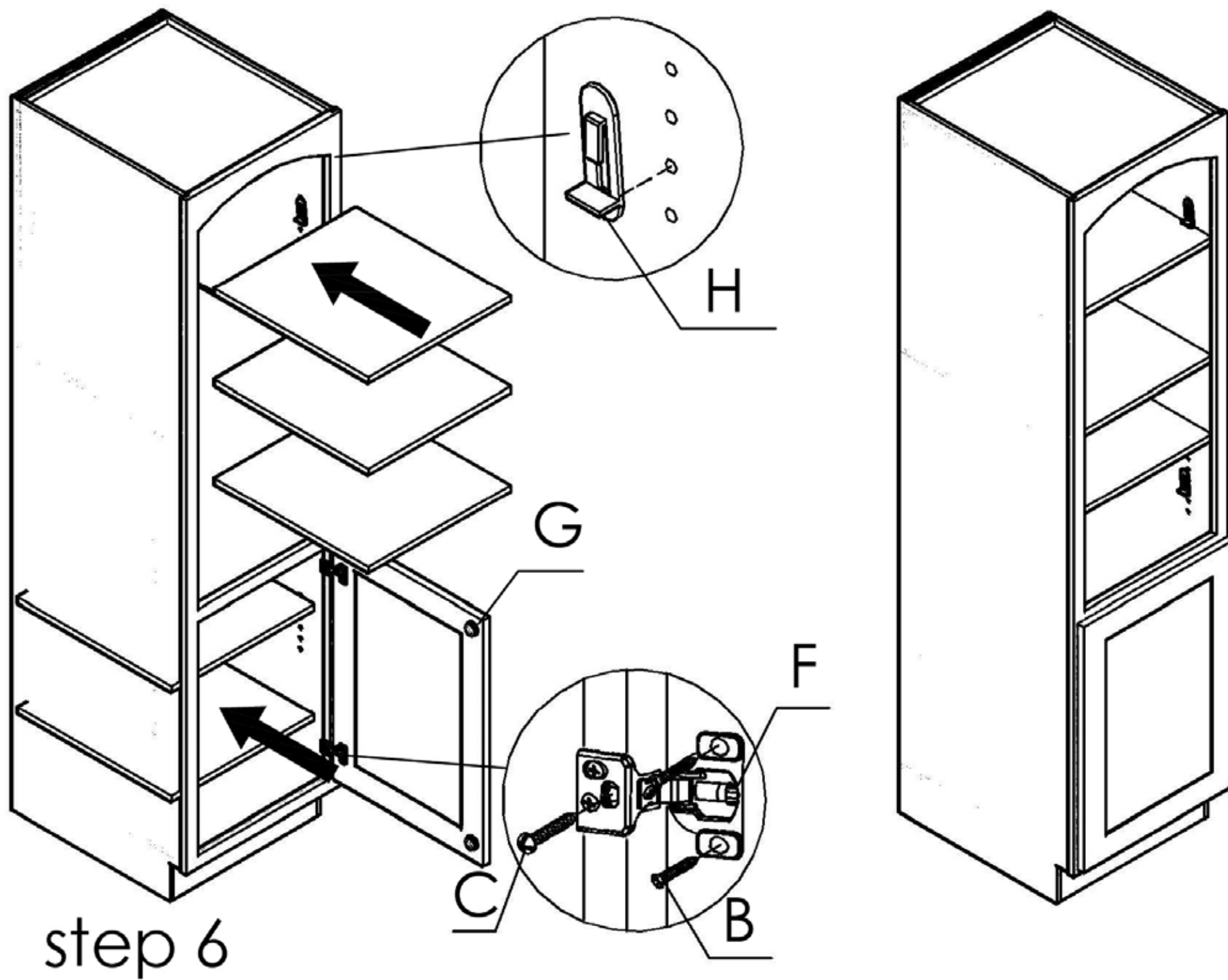

step 6

