







PART LIST

NO.	Picture	Specification	Qty
A		Screws $\text{Ø}3*1/2''$	32
B		Screws $\text{Ø}4*1''$	4
C		Shelf Clips	8
D		Metal Clip	8
E		Hinges	2
F		Screws $\text{Ø}4*3/4''$	2
G		Screws $\text{Ø}4*5/8''$	4





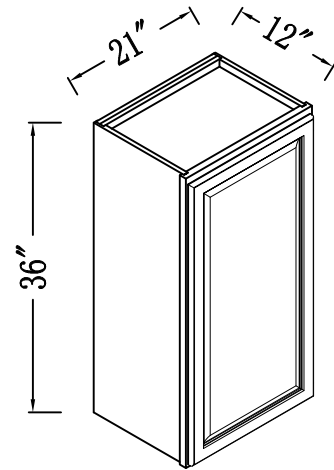

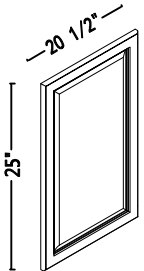
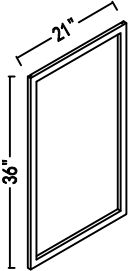
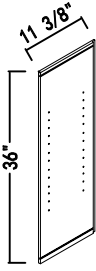
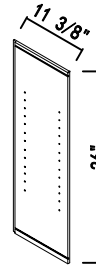
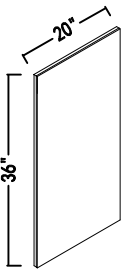
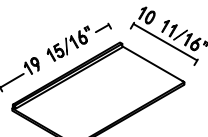
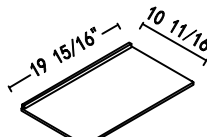
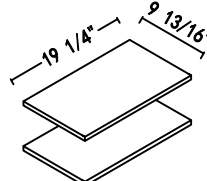

W2136
WM2136GDFI

Unit: inch

<p>1</p>  <p>Door</p>	<p>2</p>  <p>Face frame</p>	<p>3</p>  <p>Left Side Panel</p>	<p>4</p>  <p>Right Side Panel</p>	<p>5</p>  <p>Back board</p>
<p>6</p>  <p>Top Panel</p>	<p>7</p>  <p>Bottom Panel</p>	 <p>Shelf</p>		

Assembly instructions

NO.	PICTURE	SIZE	QTY	NO.	PICTURE	SIZE	QTY
A		Screws $\text{Ø}3 \times 1/2''$	32	E		Hinges	2
B		Screws $\text{Ø}4 \times 1''$	4	F		Screws $\text{Ø}4 \times 3/4''$	2
C		Shelf Clip	8	G		Screws $\text{Ø}4 \times 5/8''$	4
D		Metal Clip	8				

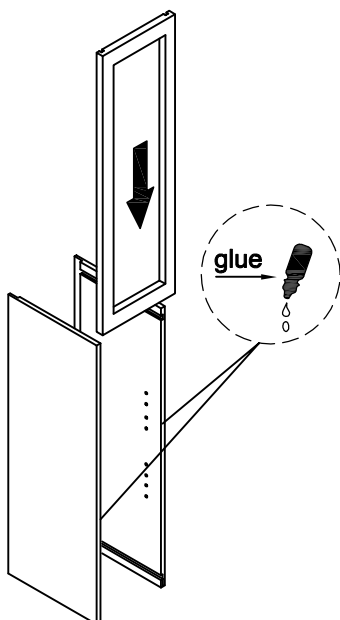

step 1

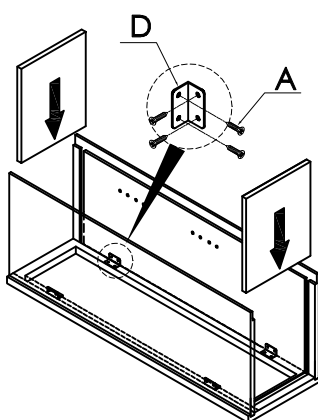

step 2

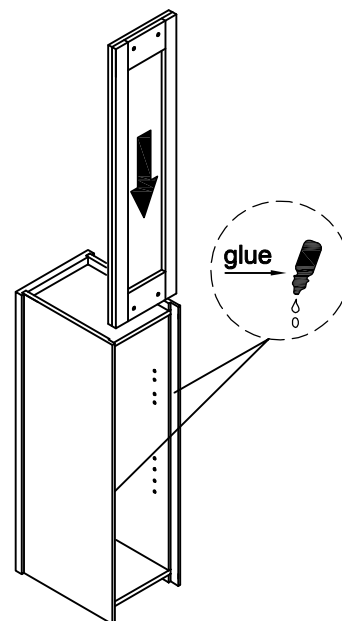

step 3

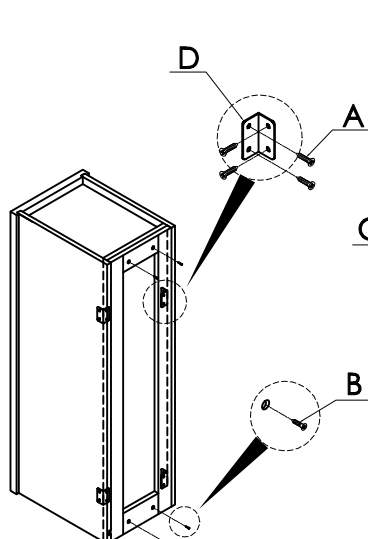

step 4

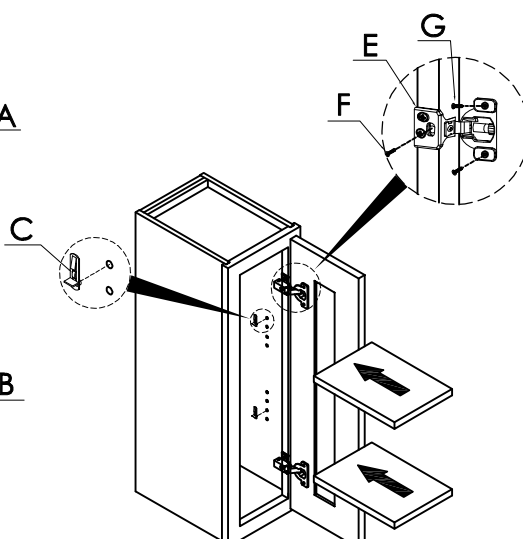

step 5

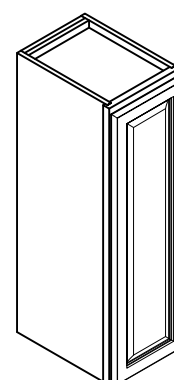

step 6